

WOLF'S PLUMB BOB NEWS 2015

Issue Q 03 AUTUMN July 1, 2015

PLUMB BOB NEWSLETTER

Author: Wolf Ruecker

www.plumbbobcollectors.info

Dear Fellow Collector,

Dear reader of the PLUMB BOB NEWS,

As always, I am searching for new material and information associated with plumb bobs.

Please feel free to share new photos, catalogs, articles or stories of a personal nature.

I welcome input from fellow collectors!

Wolf

PLUMB BOB NEWSLETTER 2015- Q 03

TABLE OF CONTENT

1. INTRODUCTION	54
2. PLUMB BOBS OFFERED ON EBAY 2004 to 2006 (selection).....	55
3. THE HOOVER DAM PLUMB BOB.....	77
4. STANLEY #5 REPAIRD.....	78
5. SHARPLES CREAM SEPARATOR 1909 with plumb bob.....	79
6. EXCELLENT PLUMB BOBS MADE BY HERB KEAN	80
7. EVERSLED AND VIGNOLES LTD THAMES TIDE LEVEL 1949	82
8. German PHOTO 1910 MASONS AND PLASTERERS.....	83
9. PRADA ADVERTISING WITH PLUMB BOB	85
10. SOMETHING TO SMILE ABOUT	86
11. REMARK.....	86

1. INTRODUCTION

In the last newsletter I started working with my archive of eBay offers of the last years beginning with 1998 to 2003. The presentation of the pictures was not really very good, I know. Now I invested some more time to present the photos.

This time I put 4x6=24 pictures of the eBay photos on one page (instead of 35 last time) to get better readable photos. Unfortunately, photo quality is limited to the quality of the photo stock which I download. Poor quality pictures are better than no photo at all. ☺

In order to get a better overview of all the pictures from the three years (288) I have created a grid:

1 to 24 for the **lines** and A, B, C and D for the **columns**. This system is made for every year 2004, 2005 and 2006.

So picture **7 C** in 2004 is the figure in the 7th line in the 3rd column (C) in the year 2004. Photo descriptions are made on the page following each page with pictures. I took the

opportunity to add further information to some of the items.

For information purposes, if I know prices, I always include them (without names).

If you print this newsletter as a booklet, the “photo-page” will be on the left side and the “description-page” on the right side. So you can see the pictures and the text together.

Perhaps you have one of these plumb bobs now in your collection. It would be great to give a feedback in this case.



In the other chapters I talk about my daily work changing information with other collectors.

2. PLUMB BOBS OFFERED ON EBAY
2004 to 2006 (selection).

2004/1

A

B

C

D

1



2



3



4



5



6



DESCRIPTION of photos 2004/1 on page 55

- 1A B** Two different pbs with long shaft in a wooden stand.
- 1C** Germany brass ca. 1920.
- 1D 2A** Germany brass. Body and tip can be screwed in upside down.
- 2B C** Heller & Brightly plummet lamp.
- 2D** From England.
- 3ABC** Mechanical KNAUS with clock winding mechanism and key. (Only two are known with a key) Patent April 3, 1962 US3027977. Now you can buy a remake



produced in China from TPI New Jersey, U.S.A. If you are interested in one (it is much cheaper as you think \$50+shipping), feel free to ask me.

Fig. below: left original Knaus, right remake from China. Identical mechanic inside, but different body (round instead of six sided) and bigger tip.

- 3D** LEISTNER "common sense" marked with # "2". Weights 2.5 lbs.
- 4A** England. Ceremonial type. (made especially for collectors?). Highly ornate. 40 oz. Offered for \$ 600.00.
- 4B** Level pin, \$ 3.00. Millwright Ron from NJ told me: *"I designed the pins and had them custom made for me here in the USA."*
- 4C** Anatolian (Ottoman) plumb bob type 1.
- 4D** Australian pb from iron and **lead**.
- 5A** Huge pb from England. 13 inch 8 lbs.

- 5B** KEEN KUTTER in wooden box (without label) and with spool.
- 5C** Huge **LEAD** body with long iron tip from Australia. Now in my collection.
- 5D** Leistner millwright 6.25 inch. In the last time Leistner and Heimbach plumb bobs are very rare on eBay. The story about



Leistner and Heimbach plumb bobs by Nelson Denny and Mike Urness you can read on www.plumbbobcollectors.info on sub page LEISTNER and HEIMBACH. There you find all information about these famous plumb bob makers from Missouri with German roots.

- 6A** A very interesting non symmetrical tip. Don't know if it works correctly.



- 6B** 5 lbs turnip shape brass.
- 6C** A tiny brass plumb bob that BUFF fixed at a business card and sent it to his clients. Nice idea.
- 6D** A very rare offer of **FOUR** Leistner plumb bobs.

2004/2

A

B

C

D

7



8



9



10



11



12



DESCRIPTION of photos 2004/2 on page 57

- 7A** A very rare offer of **FOUR** Leistner plumb bobs.
- 7B C D** STANLEY 47-173. US Design patent Des236957 Sept. 30, 1975. Produced one year only in the U.S.A. and then in England. The in America produced items are more expensive than the later made in UK. It is useable in two positions. See drawings below from the patent sheet.

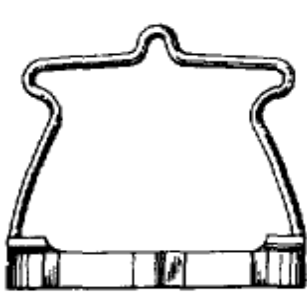

FIG. 9

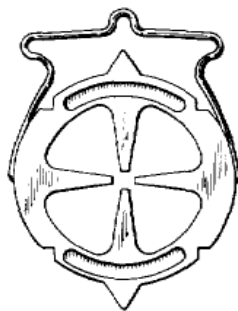

FIG. 4

- 8A** France. Internal reel. \$250.00
- 8B C** Tiny ivory/rosewood/brass pb
- 8D 9A** Patented dividers with small plumb bob. Could not find the patent from 1917. ☹️. The plumb bob is for the use on a RELIEF MAP



- 9B C D** GERMANY marked MOHR (owners name) 1844. Has an (often missing) long tip protection.

- 10A B** Australia. Rare oval shape. Marked 3 21/SS3079 ISS:13A whatever that means. Perhaps homemade.



- 10C** CANADA. Complete tool collection with plumb bobs.



- 10D 11A** 7 inches. Owners name D WANDLING
- 11B** Brass 7 inches, 3 lbs.
- 11C D** Internal reel. Excellent condition. Nelson Denny wrote about it: *FINE EXAMPLE OF CONTEMPORARY MACHINISTS ARTISTRY AND CRAFT*". 2 lbs; 6.1 in; 2.0 in. From the same maker **Rex Corbit** is this other from the ND collection:



- 12A** Canada. "Victorian". Funny combination ☺️
- 12B C** Brass hollow to fill with lead shot.
- 12D** Brass. Unusual shape.

A

B

C

D

13



14



15



16



17



18



DESCRIPTION of photos 2004/3 on page 59

- 13A** Looks like a modified finial of a fence or decoration.
- 13B C** Ivory. Now banned by US laws.
- 13D** Is it a weapon or a plumb bob?
- 14A B** Goodell Pratt #784. Produced #782, 783 and 784.
Who has a catalogue page with information?
- 14C D** I know nothing about this interesting tool. English IT Makers of Taylors Drakelite and Lignoi.
- 15A** Duck with a plumb bob as a weight to let it not swim away on the pool. ☺
- 15B** Antique Matched Set of two Presentation Brass Plumb Bobs
- 15C** Germany. Lid of a beer mug / stein with symbols of masons.
- 15D** British workers with very long plumb line.



- 16A** Germany. Faustmann's mirror hypsometer with a plumb bob to measure the height of trees. Used by foresters in Europe over 100 years. The full history of this instrument from 1854 you find on my site.
- 16B** Inclinator with pb for saws.
- 16C D** Typical Leistner pb.
- 17A** One of the huge special plumb bobs from LMSD in England.
- 17B C** A relatively simple miners plummet. Looks unused.
- 17D 18A** Huge brass with a nice tip protector cap. Often this cap is missing.

18B JUST THE RIGHT SHOE CUSTOM MADE MINIATURE COLLECTIBLES. Buy it now price \$24.00

Information from the auction text: *"This auction is for one #25115 Custom Made Shoe in the original box with paperwork and certificate of authenticity in excellent condition. ... For those who like their fashion custom made, this clever shoe really measures up. Craftswomen of all kinds will appreciate the tape measure ankle strap fastened with a designer's triangle and golden screw. To keep things "on the level," a carpenter's plumb bob dangles from the heel. Just The Right Shoe miniature collectibles are known for brilliant design and authentic look. No other artist has captured the glamour and excitement of footwear fashion like Raine. Putting her best foot forward, award-winning artist Raine offers a delightful commentary on art, culture, and taste with her popular collection Just the Right Shoe."*



- 18C** Spanish iron flat bottom pb with wooden spacer.
- 18D** VAJEN patent Nov. 14, 1882. Produced in 1, 2, 3, 4 lbs.



We recommend it in preference to all other combination bobs, and guarantee it to give perfect satisfaction. This Plumb Bob is made in four sizes :

1 pound.....	\$3 00
2 pounds.....	2 50
3 "	3 00
4 "	4 00

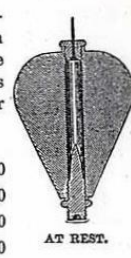

A complete set of four from the Nelson Denny collection looks like this:



2005/1

A

B

C

D

1



2



3



4



5



6



DESCRIPTION of photos 2005/1 on page 61

1A B Patent US 5791061 Guiseppe Modugno, Aug. 11, 1998. Marking plumb bob. Works like a ball point pen. See patent drawing.

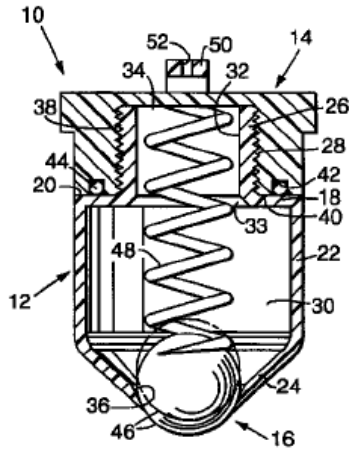

1C D Two different Italian plumb bobs (or decoration pieces) with brass body and very long iron tip.

2A British 3 inches, brass.

2B Italian iron.

2C Italian brass.

2D3AB Germany. Brass from 1844. (Already offered in 2004)

3C D Typical South America. Usually the plumb bobs in South America have a **FLAT BOTTOM**, but some of them have a relatively **big tip**, as shown in the figures below.



The maker Gampper in Germany tried to sell a flat bottom plumb bob with a common **small tip**, but the clients in South America did not want it. The photos below show a flat bottom from the



catalog since 1975 and the zinc and brass version with a thread to screw in a common tip.



4A England. Sold for more than 200 GBP

4B C Sold for \$500.00 +

4D Fine brass with steel tip. Start with 150GBP

5A Very rare offer. Set of THREE K&E 6487 (with internal winding mechanism) in wooden box for more than \$500.00. I found it in the collection of ND as #554 with the remark below: *"THREE POINT SYSTEM USED AS EARLY AS 1898.* (that is the

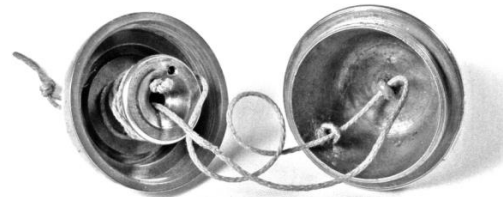

guiding system of the cord inside. These in the box have two points. See fig. below) *TWO POINT SYSTEM CONSIDERED TO BE AN IMPROVEMENT APPEARING IN K&E CATALOGUE 1913. BOUGHT FROM RETIRED CANADIAN MOUNTY WHO WORKED FOR HIS FATHER AS A TEENAGER AS A SURVEYOR'S STAKE*

MAN. IT WAS A SILVER MINING OPERATION IN NORTHERN ONTARIO KNOWN AS THE GOWGANDA DISTRICT."

5B Tiny pb from BUFF.

5C Edward Preston brass with string reel.

5D British display in a tool shop 10 in.

6A Extremely ornate. Over \$ 500.00. 3 lbs +

6B C Small plumb bob in brass tube.

6D Looks like Germany in the 1920s.

2005/2

A

B

C

D

7



8



9



10



11



12



DESCRIPTION of the photos 2005/2

- 7A** Brass reeling (from France?)
- 7BCD** This pb is one of the so-called HAMBURG plumb bobs. It is a long story and began that a seller offered such a pb with a coat of arms / crests (Wall with three towers) as "Three holy men on a wall" (Holy trinity). Sellers are sometimes very creative finding interesting descriptions to raise the price. ☺. I found that it was simply the CITY GATE OF HAMBURG, Germany, a big harbor in the north of Germany. We know this weapon in different shapes:

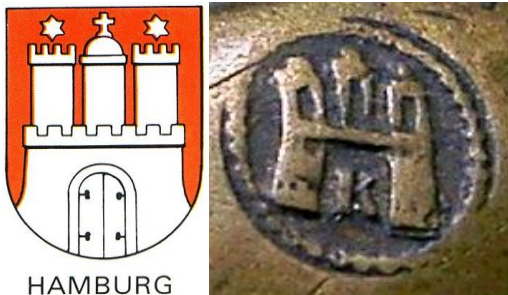

They came on the market in a David Stanley auction long time ago and later by H. B., a well-known Swiss dealer in Australia and 2004 in a Martin Donnelly auction, offered as "Holy trinity". I know some friends who have one.

The reversible tip (left) is different (better) compared with the German similar shaped plumb bob from the Berghaus catalogue 1913. (right)

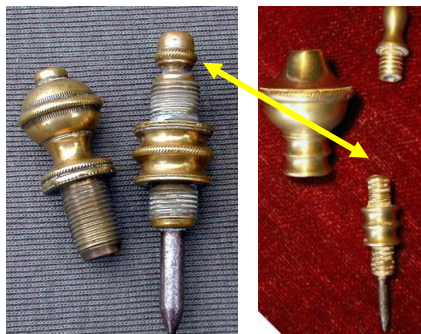

In 2012 was offered in Dresden, GER one with a protection cap for the tip. Very Rare.



8A B C LEISTNER

8D 9A Three part unusual brass pb. Bought by ND. His #567 "OLD BRASS BOB WITH TIP PROTECTOR CASE, FIXED BOBBIN ON UNDERSIDE OF CAP. HOLLOW FOR FILLING W/ SHOT" Fig. right is the complete presentation. Estimation in the MJD auction Sept. 2012 \$300-\$600



9B C Looks similar to the Hamburg series (without mark?).

9D 10A Early heavy brass with iron rod.

10B C Interesting Georgian from England.

10D 11A Screw on point protector

11B Rocket shaped steel pb

11C Heavy brass from the 1800s

11D Stanley-like build in reel. (on top). Below a Stanley #5 from cast iron.

12A A **Bergman Tools Co. Buffalo** cap to adjust and fix the line. No Patent! The line is laid in a slot and then the brass part is turned to jam the string. More about "FIX THE STING" see my patent newsletter 2007-16.



12B Beautiful with decorated detail.

12C D Reversible brass and iron pb.

2005/3

A

B

C

D

13



14



15



16



17



18



DESCRIPTION of photos 2005/3 on page 65

- 13A B** Spring loaded tip. 5 parts.
- 13C D** Matching pair of huge plumb bobs.
- 14A** Brass in wooden box. 3 lbs.
- 14B** Sold for \$86.00
- 14C D** This is not a plumb bob, but a cut part from a pendulum watch. I got a question from an American collector "Hi Wolf, are you familiar with this type of bob?..." and searched for this "plumb bob". Now I have two in my collection.
Here is my answer:
"... FINALLY I FOUND THE ORIGINAL PART:



VINTAGE 1960s – 1970s GERMAN WALL PENDULUM CLOCK ELEXACTA (the complete clock is swinging all the time) MADE BY AUG. SCHATZ Black Forrest, GER. YOU CAN BUY



THE CLOCK FOR 183 EURO. IT IS A CLOCK PENDULUM WITH REGULATION OF THE LENGTH TO ADAPT THE PENDULUM TO GET THE CORRECT TIME. The "plumb bob" was cut from the long pendulum rod.

His answer: "Wolf, your research abilities are both amazing and scary! It certainly makes sense that the central shaft had the incremental markings. Bravo on a great job.

- 15A B** A. L. THOMPSON MFG, LOWELL, Mass. (left) together with H A WILLIAMS,

Boston (right) the most elegant shapes. My favorites.

- 15C** Chalice shape with acorn cap.
- 15D 16A** Plumb level 1950 Germany
- 16BCD** Hanging trade sign in a tool shop, U.S.A. Now in a collection in Turkey.
- 17A** Plumb square
- 17BCD** Heimbach 5 lbs
- 18A B** Hellers & Brightly miners plummet. A similar one (fig. right) with box was 2012 sold for \$738.00. Usually one miners plummet costs nearly \$1000.00



- 18C** Filled with lead shot.
- 18D** French patent FR406122 Aug. 14, 1909 Max Schott, Paris. "Fil à plomb rationell". (Efficiently plumb bob.) It

N° 406.122 M. Schott Pl. unique

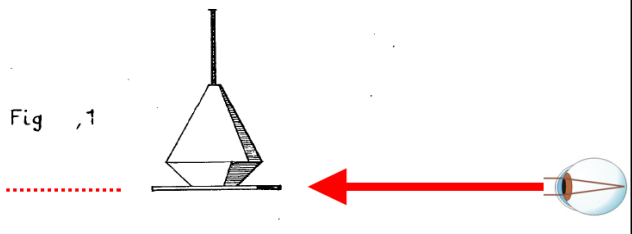

works like an upside down level. The surveyor is looking along the HORIZONTAL plate at the bottom of the plumb bob. See my modified drawing from the French patent above.

2005/4

A

B

C

D

19



20

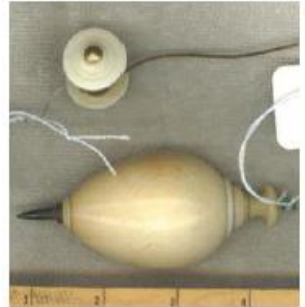

21



22



23



24



DESCRIPTION of photos 2005/4 on page 67

19A B C Extra-large plumb bob in wooden case with an interesting history. Full body taper, separate threaded height adjuster. 15 lbs, \$455.00 ND# 684. Used for railroad building. The seller of this beauty told ND: *"You are correct in guessing that I may have an interest in railroading and train related subjects. I retired from the Southern Pacific railroad in 1997 during our merger transition with the Union Pacific. I spent my first few years with Southern Pacific in the Track and Bridge Departments starting in 1952. In 1959, I transferred into the Engineering Department and worked on the Oregon Division, mostly out of Portland and Eugene, until my retirement in 1998. Spent most of my time as a Field Engineer working on everything from maintenance of way to construction projects.*

As for the plumb bob, in the earlier years we used it mostly on bridge and trestle projects to transfer centerline control to the ground in connection with re-driving wood and steel bridge pile bents. Also used it over some of the coastal lakes on the Coos Bay Branch between Reedsport and CoosBay. This was usually necessary in order to transfer centerline when replacing upper portion of bents above water with fabricated frame bents. The piling below water level was sound so existing bents would be cut-off when water level was lowest in the lakes and the new frame bents would be set on the freshly cut-off piling. From talking to some of the older guys, the plumb bob was probably around as far back to the 1920s or 1930s.

- 19D** Knaus patent pb. Sold for \$312.00
- 20A** Ivory 3 oz. \$855.00
- 20B** Unusual shaped brass.
- 20C** Rare reel inside.
- 20D** Ivory + ebony. Start price 150 GBP
- 21A B** German combination plumb bob for architect. Interesting shape modification.
- 21C** Lotsenbruderschaft Ovelgönne 1748. Badge for the guide for ships.
- 21D** Box with masonic / free mason tools. 966€.
- 22A** French iron plumb bob.
- 22B** Offered as NAPOLEAN plumb bob. Not sure.

- 22C** Russian mechanical plumb bob. Inside it looks like on the photo below:



- 22D** Magnetic holder from France.

- 23A** On eBay offered as: Old Lodge Masons Masonic Plumb Bob Level Tool. Offered in the MJD auction 2012 as:



An unusual "FIXTURE" TYPE PLUMB BOB having a wooden frame to hold the bob. Appearance is circa 1900 . Nearly all of the original red paint remains on the frame. From the Collection of Nelson Denny, Hadlyme, Connecticut
Estimation \$40 to \$80

- 23B C** France. Copper medal 27mm diameter.
- 23D** Typical plumb bob from Portugal with wooden/brass spacer
- 24A B** Germany 1850s
- 24C** 7 inches nickel plated in wooden box.
- 24D** STANLEY 47 173 made in USA 1975 \$204

2006/1

A

B

C

D

1



2



3



4



5



6



DESCRIPTION of photos 2006/1 on page 69

1A German official coin 10 Euro remembering the German architect Karl Friedrich SCHINKEL. 1781-1841. Mason with A-level on front. Reverse see fig right:



1 B English patent GB 34836-60 aluminum level-pencil-plumb bob

1 C + D marked ALFRED SHIRLEY Ltd 1861 1945. From the collection of Ulrich Biber I know two other pbs (figs. below): Brass



in the same shape like the eBay pb and an English shape. Both are marked Alfred Shirley Ltd, but without the dates 1861-1945. The maker is: Alfred Shirley Ltd. 3, Clifford Street, Birmingham B19

2A+B Gyrostatic patent GB 136/1908

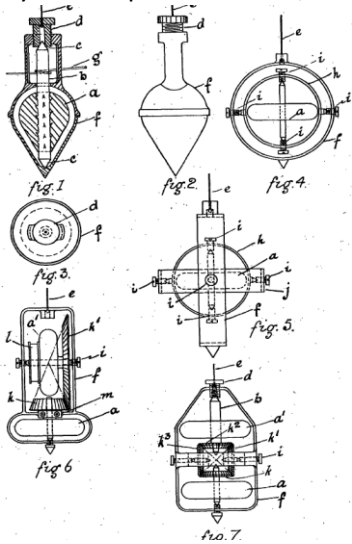

Plumb bob bought from Australia. Only one item seen. Inventor Fredric Samuel Carter. Fig. above shows some of the other shapes that the inventor proposed in the patent drawings.

Nelson Denny made a test and found that the plumb bob does not come

faster to rest than a common plumb bob.

In my **Patent Newsletter 2007-13** you can read more about this very single tool.

- 2 C** Berger & Sons \$235.00
- 2 D** BIG DAVE 12, 14, 24 oz
- 3 A** Simple internal reel. Dome cap w/brass thumb nut brake. 6.6 oz; 4.1 in high; 0.7 in width.
- 3 B** Boxwood quadrant. Starting price \$1850.00
- 3 C** Brass 5 inch.
- 3 D** Brass with wooden spacer in walnut case \$265.00
- 4A** Brown & Sharpe 790 mercury 12 oz.
- 4B** Bulgaria 5 cm Architect plumb bob.
- 4C** China iron.
- 4D** Cooke. Removable protection cap.
- 5A** From German decimal scale.
- 5B** Old German. Rare brass.
- 5C** Driggs patent US469631. Ammunition.
- 5D** Long English brass ornate.
- 6A** Extra wide iron \$128.00
- 6B** France. Brass plumb bob (fil à plomb) with spool.
- 6C** Faked inscription in Chinese brass plumb bob. The seller used a shape that was



Original mark with name of owner or shop

China 3



FAKED: NEW engraving in an old pb to make it very old.

Sold as 1876 PB from > 1911, mark says : "The second year of Guangxu" (emperor in Qing dynasty from Feb.25, 1875 – Nov. 14, 1908 => 1876) ☹

W. Rücker
wolfg.ruecker@t-online.de

Plumb bobs of the world
May 2006

53

produced after 1911 for this "1876" pb. ☺. The inscription was shiny, because the text was cut recently into the surface. See page from my presentation.

6D French brass plumb bob with interesting handle (spool).

7



8



9



10



11



12



DESCRIPTION of photos 2006/2 on page 71

- 7A Forged French spool with brass flat bottom p b
- 7B French brass with internal spool
- 7C French brass with external spool
- 7D Fish for storage the string
- 8A French double cone 325 grams
- 8B French brass. 123€
- 8C French special carpenter. Lead.
- 8D French special carpenter. Brass.
- 9A French special carpenter p b with two wire drilled to hold the line
- 9B French special carpenter p b with three wire drilled to hold the line. Lead. The figure below shows a display in my small museum, where I show how this only in France known carpenter plumb bob is used.



- 9CD 10A Rare French reversible brass plumb bob. Pictures with "bell down", "bell up" and parts. Offered from New Zealand
- 10B C Very small with golden ornate top. Looks excellent.



plumbbobwolf@t-online.de

- 10D H A WILLIAMS Mfg Boston. Very elegant shape. \$90.00
- 11A Hidden string storage compartment
- 11B Highly engraved
- 11C Home made. Looks great.
- 11D Internal reel 1888. Maker FRASSE, NY. ND# 246. Sold for \$665.00 EARLY TUBE THREADING INTERNAL REEL 1lbs 2oz, 6.25 in high. From outside is nothing to see from the internal reel.



Advertising

Improved Plumb-Bobs.
The illustrations, Fig. 8, represent improved plumb-bobs, which are put on the market by Frasse & Co., 92 Park Row, New York. These plumb-bobs are



Fig. 8.—Improved Plumb-Bobs.

- 12 A German iron. 8500 grams.
- 12B Italian huge decoration. No p b.
- 12C Ivory \$230.00
- 12D Ivory and sterling silver. Home made.

2006/3

A

B

C

D

13



14



15



16



17

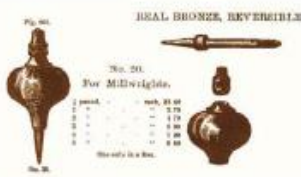

18

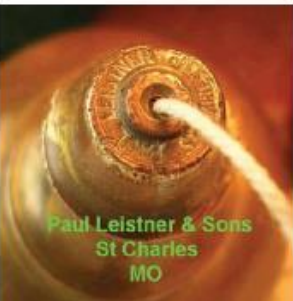

DESCRIPTION of photos 2006/3 on page 73

- 13A Ivory or bone
- 13B JC ULMER CLEVELAND
- 13C D Keuffel & Esser internal winding THREE points.
- 14A Leistner #7 \$425.00
- 14B From LETVIA
- 14C BUSH lightning US patent 1357270 Nov. 2, 1920 Automatic plumb bob. \$457.00

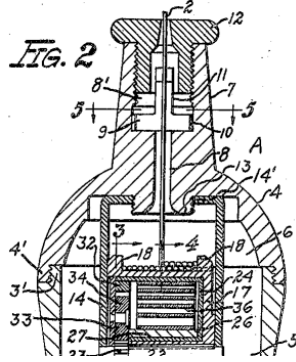

14D England. LMSD. Lignum vitae wood.

15A B Plumb bob made from a modified marked Lunkenheimer oil cup.

15C Painting. Mining in Ontario.

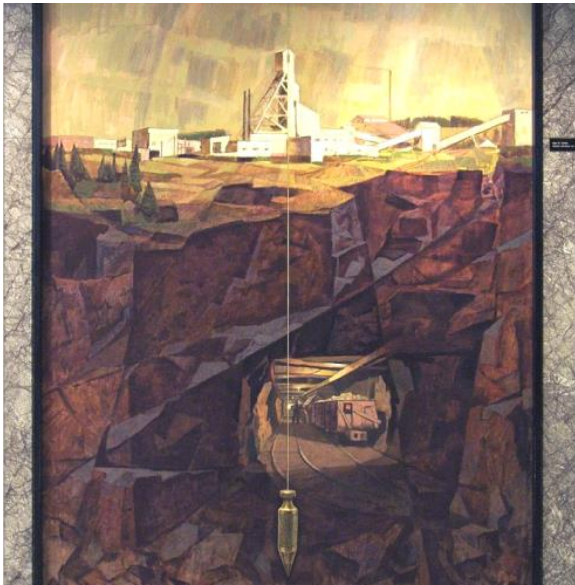

- 15D Mjdttools 300\$
- 16A Monster carrot 8 in 4 lbs.
- 16B Plumb level from France. 90€
- 16C Ottoman plumb bob type 2 from Israel
- 16D Pair of Bridge City Tools
- 17A B Paul Leistner St. Charles
- 17C Leistner catalogue page with weights. (see next column)
- 17D 18ABC Paul Leistner, offered from Australia. Excellent photos from A.L.

REAL BRONZE, REVERSIBLE.

Fig. 803.

No. 20.
For Millwrights.

1/2 pound,	-	-	each,	\$2 40
1 "	-	-	"	2 70
2 "	-	-	"	4 70
3 "	-	-	"	6 00
4 "	-	-	"	7 20
5 "	-	-	"	8 40

One only in a Box.

18D Perfection 5 lbs. Here are 3 PERFECTION from the ND collection and a set of 5 with wooden box from Ed Leigan coll.



This boxed Perfection was on eBay in 2010



The inventor of the Perfection is M.D. Converse. Patent US787896 Apr.25, 1905.

Special is the position of the plumb bob, laying on a (flat) surface (does not work in a tool box ☹). When the tip and the beam have contact to the ground, the body is FREE of contact (no damage of the thin brass cover). See figures below:

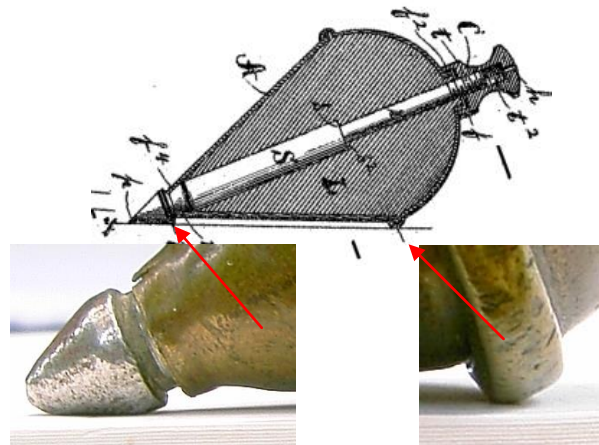

2006/4 **A**

B

C

D

19



20



21



22



23



24



DESCRIPTION of photos 2006/4 on page 75

- 19A** Perfection. Mark on the top.
- 19B** A t-shirt with plumb bobs. Maker?
- 19C** Mining plummet lamp \$1275
- 19D** Preston. 1 lbs. 30 GBP
- 20A B** Richard Kell, England. Sold for \$350 ☺.
You can get it much cheaper when you buy it directly from Richard in GB.
- 20C** Roman. Bronze. 70 mm diameter.
- 20D** RUSSIAN MILITARY PLUMB BOB UNDER

THE TRIPOD FROM A SURVEYOR. The weight in the middle of the line should "break" the swinging of the plumb bob and stabilize it earlier (length of the swinging line is important for the time until the

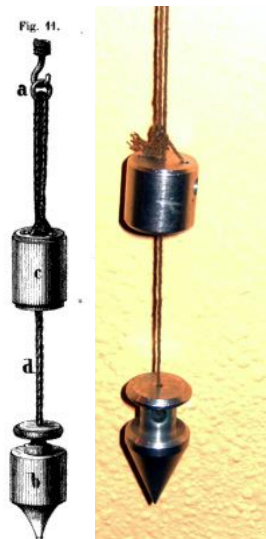

pb comes to rest). The weight has also the function of a LINE SHORTENER. The plumb bob is stored in a Bakelite box. (Bakelite is often used in Russia for small boxes).



- 21A B** Tip protection. Australia. \$120.00
- 21C** Spain. Marked SILVERIO 1893. With wooden spacer.

- 21D** No plumb bob, but SNUFF BOTTLE with spoon.
- 22A** Spain
- 22B** Stanley #5 cast iron. \$143.00
- 22C** Stanley with original BRASS HOOK.
- 22D23A** Suverkrop MICRO (the head is patented). Special edition as No. 9 MINING SPECIAL
- 23B** Sculpture: the drunken mason ☺



- 23C** Tie needle/pin (in my collection)
- 23D** 2 lbs. Brass and wood.
- 24A** 2 lbs. Mercury filled.
- 24B** Looks new with short protection cap.
- 24C** Watch chain with plumb bob



- 24D** Edmund Douglas. WELLS, California, U.S.A. patent US2376407 May 22, 1945
Plumb bob reel (to fix with a nail in WOOD)



3. THE HOOVER DAM PLUMB BOB

From the Nelson Denny collection and the Martin Donnelly auction we know the so-called "HOOVER DAM PLUMB BOB"

The history began with the text in Nelson's inventory sheet where he called it a

"HERMAPHRODITE" LINE PULLER / PLUMB BOB, HOOVER DAM 1933



Fig. left from ND inventory sheet.

His remarks following the information from the seller:

"HERB DANFORTH B. 1915, D. 2003. LINEMAN ON HOOVER DAM 1933-1937. CONDUX MANUFACTURES TOOLS AND PARTS USED IN THE OVERHEAD ELECTRICAL LINE STRINGING BUSINESS. IT IS A TOOL THAT HAS A TWO FOLD PURPOSE. FIRST IT CAN BE SLICED ON THE END OF AN ELECTRICAL CABLE AS IT COMES OFF A SPOOL IN ORDER TO KEEP SOME TENSION ON IT AS THE CABLE IS UNSTRUNG FROM ONE INSULATOR TO THE NEXT. IT KEEPS THE KINKS OUT. THE SECOND USE, IS A PLUMB BOB, HUNG FROM THE CROSS TREE OF A WOOD POWER POLE, USED TO ALIGN THE POLE BY EYE TO VERTICAL IN THE OPERATION OF SETTING A NEW POLE IN A HOLE. IT IS NOTHING BUT A WEIGHT WITH A TIP. A NUMBER OF THEM WOULD HAVE BEEN CARRIED AROUND IN A BUCKET, IN THE BACK OF A LINE CREW'S TRUCK, TO BE USED AS DISCRIBED. TIP IS AN ORIGINAL FEATURE."

On eBay now in 2015 was offered again this tool, but with a strong line fixed to the ring.



It came from the MJD auction, where it (now added by a big rope) was sold for more than \$300.00 from the ND collection to a collector who now was selling it again. I asked the company CONDUX for more information, but the answers did not match (where indifferent). ☹



Fig. left: eBay offer 2015

Text from the actual CONDUX catalogue:

The ultimate solution for a connection as strong as the cable itself. Condux Crimp-on Cable Pulling Eyes are virtually impossible to pull off and seal the cable against water and air contaminants during the cable pull.

They told me that they did not sell this CONDUX marked item in the 1933s. (I don't believe it).

On the web site of CONDUX you read: Condux International has been **manufacturing cable installation tools and equipment. ...**

I found that the name CONDUX was used by this maker since the beginning in the late 1800's in one of his multiple small companies. The company has been in the same family since it started as a saddle leather manufacturer.

Actually they sell these PULLING EYE SYSTEMS: (Perhaps they don't know that they sold it already long time in the 1930s? ☺)

The first one looks very similar to our "Hoover Dam Plumb Bob".

Crimp-On Telephone Cable Pulling Eyes*

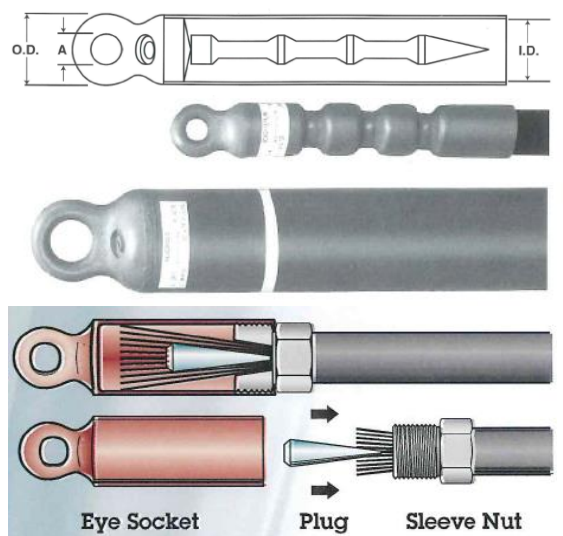

4. STANLEY #5 REPAIRD

I bought for \$30 a repaired well-known patented Stanley #5 cast iron plumb bob. Usually collectors don't buy broken or repaired tools, but for me it was a piece for my newsletter. It shows that users repaired CAST IRON, although commonly it is known as "impossible" for non-professionals.

A specialist, Lincoln Electronic said on the site:

<http://www.lincolnelectric.com/en-us/support/welding-how-to/Pages/welding-cast-iron-detail.aspx>

"Cast iron is difficult, but not impossible, to weld. In most cases, welding on cast iron involves repairs to castings, not joining casting to other members. The repairs may be made in the foundry where the castings are produced, or may be made to repair casting defects that are discovered after the part is machined. ..."

Below some photos of the different three sizes from Stanley #1, #3, #5 and my welded Stanley # 5.

By the way I attach the very rare other plumb bobs made by Bodmer, with (extreme) prices that I found in the web.

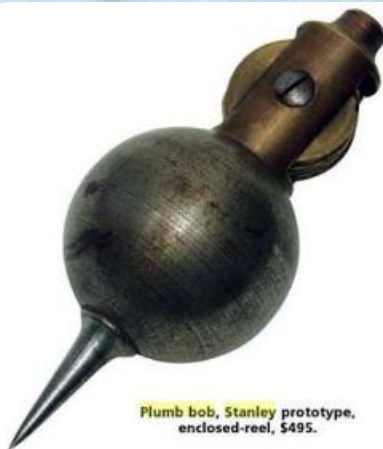

Plumb bob, Stanley prototype, enclosed-reel, \$495.



Plumb bob, C. Bodmer's Design, \$1,705.

The Stanley internal reel type plumb bob designed by C. Bodmer ca. 1931, Lot 477, the smallest of the three sizes that were made, had 95% of the original orange paint and 90% of the Stanley decal. It was never offered in a Stanley catalog, was in Fine condition and went for \$3,300.



Lot 477

5. SHARPLES CREAM SEPARATOR 1909 with plumb bob

I found a new profession using a plumb bob. The farmer's wife!

Dear member of the MWTCA and EAIA (I am member of both), do you have such a machine in your collection or do you know a museum or collection with such a CREAM SEPARATOR WITH A PLUMB BOB? I would like to get a close up photo (and not only a drawing in an ad) of this very special plumb bob.

Thanks for your help.

HOW CREAM MAKING WORKS:

http://www.forgottenbooks.com/readbook_t



Here I Am

The plumb bob is one of the handy improvements on the 1909 Sharples Tubular "A" cream separator. It adds miles to the great lead Tubulars have always had over all other separators.

This "plumb bob" enables you to set the 1909 Tubular "A" perfectly level in a minute—quicker than you could find the spirit level needed to set any other separator. You can always tell, by a glance at the plumb bob, whether Tubular "A" separators are level, thus always keeping the Tubular up to its very best work. Just another example of the "up to the minute" and "away ahead of the rest" character of Tubulars.

Tubulars Are Different From All Other Separators

Tubulars are built on absolutely correct principles—that is, Tubulars have a bottom fed bowl hanging below a simple, frictionless ball bearing. The one piece frame and the permanent, compact, strong construction of Tubulars enables us to add to Tubulars some very handy devices which it is impossible for other manufacturers to use on their constantly changing common "bucket bowl" machines.

The incorrect principles of common "bucket bowl" machines—that is, a top fed bowl set up on top of a spindle—make all such machines unsatisfactory and necessitate constant changes that are merely makeshifts and not improvements.



The Sharples Separator Co.
WEST CHESTER, PA.

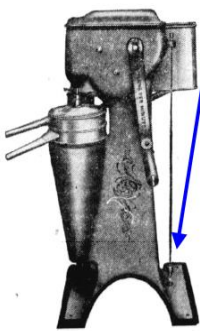

1909 Tubular "A"

The Path to Purity

Sharples Tubular Cream Separators not only extract all cream from milk, but also remove, from both milk and cream, that unwholesome sediment and viscous matter you so dislike to see remaining in your glass. A Tubular opens the path to purity in dairy products.

For One Cow or Many

The superiority of the 1909 Tubular "A" is too universally acknowledged to need comment. The low supply can, enclosed self-oiling gears, bottom-fed bowl suspended from single frictionless, ball-bearing, and the plumb bob attached to rear of frame for leveling machine indicate unrivalled excellence. Made in all sizes. Suitable for one cow or many.

Write for Catalog.

THE SHARPLES SEPARATOR CO.

WEST CHESTER, PA.

CHICAGO, ILL.

SAN FRANCISCO, CAL.

PORTLAND, ORE.

TORONTO, CAN.

WINNIPEG, CAN.

287



Write for catalogue
THE SHARPLES
SEPARATOR COMPANY
WEST CHESTER, PA.

It is the easiest thing in the world to level the Tubular "A" cream separator shown here. Simply wedge up under the corners of the machine until the point of the plumb bob hangs directly over the point of the plumb bob center, or plug, set into the base of the frame. Done in a minute and always right. Observe the low supply can on the Tubular—you need not move it to take out the bowl.

A pin with a cream separator, offered on eBay:



xt/Halcyon_v30_1000783083/331

The Path to Purity Sharples Tubular Cream Separators not only extract all cream from

plumbbobwolf@t-online.de

6. EXCELLENT PLUMB BOBS MADE BY HERB KEAN

I got photos of excellent nice plumb bobs from a reader of this Newsletter, David P.

He told me that HERB KEAN from Morristown, NJ, U.S.A. (also a reader of this Newsletter) made these plumb bobs for him and his family. I knew that Herb is 87 years old.



(The photo is a few years old. It was the night he was awarded the Distinguished Military Service Medal by the local Veterans Administration. This is only a minor award, and not the premier Distinguished Service Medal given by his Federal Government.) That looks for me to be interesting information for all collectors. To not show you the pictures only, I asked Herb to tell us more about making such nice tools. Here are some details from his email:

"Wolf - Here are some answers to your questions:

- 1) I liked wood and carving since a teenager.*
- 2) I started collecting antique tools in 1974.*
- 3) I started repairing antiques around 1976.*
- 4) I taught Machine Shop in the Management Training Program for Curtiss Wright and later rose to Director of Quality Control. They sent me to Stevens Institute to get a Masters Degree in Engineering.*
- 5) I joined the EAIA in 1976.*
- 6) Myself and a few others started the CRAFTS of New Jersey in 1979. (Collectors of Rare And Familiar Tools Society;
<http://www.craftsofnj.org/>)*
- 7) Emil Pollak and I wrote the first book that he published (1991) on Antique tools, and I wrote 3 more on Antique Tools after that.*
- 8) I have a 9" South Bend Gear-Box lathe that's about as old as I am (87). I had a fabulous wood lathe but found that I could do everything with greater accuracy on the machinist lathe. With it I can work to +/- .001" in steel, brass, wood, and ivory. I have the gear box that allows me to cut almost any size and pitch thread.*
- 9) I have a 14" Rockwell band saw and a 6" Jointer, along with 5 double shaft grinders and polishers, a 6"x 48" sander and many hand tools.*
- 10) I have made about 25 plumb bobs over about 15 years, most of which went to Dave*

Pollak and Sherri. Lately I try to make something different for them, as they have quite a collection. My last three were the carrot, the pumpkin and the "open" bobs.

11) I have made an Ivory-tipped center-wheel rosewood plow, some miniature tools, and many specialty tools.

12) I have a large collection of true antique tools which I am now selling piece by piece.

13) I have been a speaker for many organizations, and have been on 2 television shows.

*14) Below is a bob that I kept. It is solid brass, 8 1/2" long, 2 3/4" largest diameter. Its container is walnut with brass top and bottom. It fits perfectly. The bob weighs **5 1/2 pounds**. It and its container weigh 8 1/2 pounds. Together they are 11 1/2" tall. **It's my favorite.***

Hope this will do it for you.

Herb"

Now we know all about the plumb bobs below. Thank you, Dave and Herb to share this information with other plumb bob collectors.





7. EVERSLED AND VIGNOLES LTD THAMES TIDE LEVEL 1949

This rare piece of advertising ephemera has been carefully removed from a vintage 'Punch' magazine

Date: 1949 original page - not a photocopy

BOADICEA
and the
PLUMB-BOB

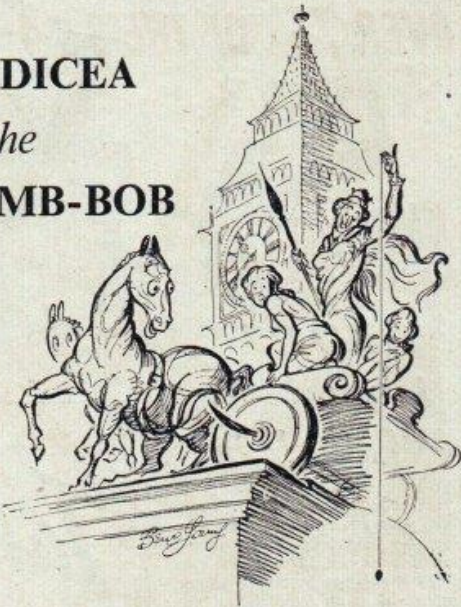

At this very spot beside Westminster Bridge, an Evershed *automatic* plumb-bob records the Thames tide level with uncanny accuracy. Evershed's are acknowledged experts in tide gauges and apparatus for remotely indicating water levels in docks, reservoirs, tanks, etc. Write for Publication No. PH 221.

EVSERSHED AND VIGNOLES LTD
ACTON LANE · CHISWICK · LONDON · W-4
Evershed Indicators and Recorders · Megger Testers

5/12



After I bought the ad from 1949, I asked a friend from England to visit this site near the Big Ben to make actual photos. Here they are. Thank you Gwyneth.

I also asked the Port of London for more information about the tide gauges, but got no answer. ☹

Finally I found the tide gauge station. ☺

In a blog I found: **Beside the riverbank is a tall octagonal copper case, green in hue, containing an unseen tide gauge.**

On a site from Romania I found: "Few visitors stop and look at Thomas Thornycroft's dramatic bronze statue of Boudicca (or Boadicea) at the Westminster end of the bridge, erected there, somewhat controversially, in 1902. Boudicca was famous for leading a revolt against the Romans in AD 61, during which the city of Londinium was burnt to the ground.

Below the statue, beside the pier, is a curious octagonal copper structure, which seems to serve no useful function.

In fact, it once housed scientific instruments that were used to measure the tides."

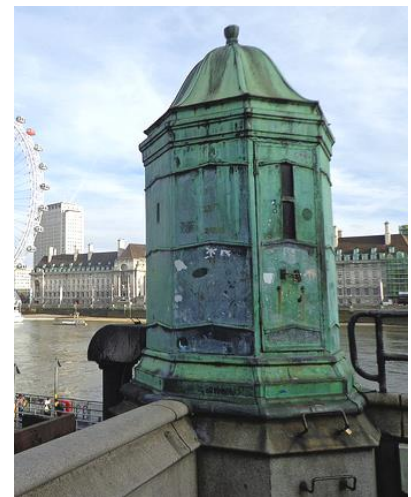

On Google Earth you have a good overview.



8. German PHOTO 1910 MASONS AND PLASTERERS



Last month I bought this original b/w photo 12 in x 10 in with a group of German masons and plasterers. (Maurer + Gipser). As usual I try to research the background history associated with this group of early construction contractors.

The headline was



The photo was made by a well-known photographer in the town Weingarten, Gustav Bopp sen. Many of his photos can be found on the internet. His specialty were pictures of people in uniforms and costumes.

Weingarten is a town near to Ravensburg not far from Lake Constance in southern Germany.

Let's have a look to this photo.

It shows a group of 11 masons and plasterers during a festival in their costumes and with some of their tools, beer Steins or wine jugs.

All, except the youngest, wear a beard – a so called “Kaiser-Wilhelm-Bart”.

The German Emperor Wilhelm (1859–1914) was wearing such a special beard. (fig. right)



The German Emperor Wilhelm's beard was popular among his loyal followers and became a part of popular fashion, allowing many Germans to exhibit their national pride.

We can see three different types of costumes. The black one in the middle seems to be the master mason. Also the second from left has a different costume and both are holding a drawing roll, containing building plans in their left hand. The others are workers. The group all wears the same hat and apron, with the exception of the master.

Tools: To present their profession they have chosen special, very big tools and symbols.

Three big hammers (two different types), a huge trowel, a big plumb bob and a sign, made by thick cord with tassel, a spirit level combined with a plumb level (with plumb bob) and a small trowel.

The youngest mason holds a sign - the symbol of the masons/plasterers – with divider, trowel and a square surrounded by a garland of pine branches and flowers.



The three workers sitting in front, hold special beer Steins or wine jugs that were used in ceremonial meetings, not in daily life.

These workers seem to be stationary and from the area where the photo was taken, since no one is wearing a big earring, typical of traveling journeymen.

At the first glance I thought the huge tools were big reproductions of real tools made from light material like cardboard or wood. But looking closer with a magnifying glass, I saw there were real tools. In addition, the hammer in the foreground has an unusual grooved peen, a detail no one would add to a "reproduction tool" for a festival.

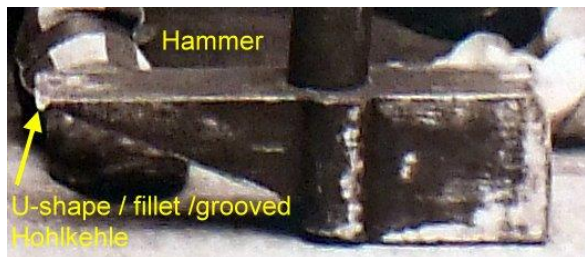

Contrary the two hammers on the shoulder of the workers have common peens. (figs. below).



Also, the very large trowel held by the worker in the center of the photo is very uncommon for a "staged photo"

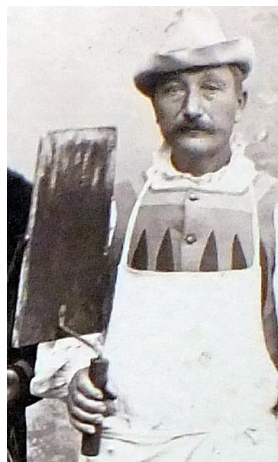

For me of interest are the two workers at the right side. They are holding a "big" plumb bob and a specially made symbolic sign from different tools.

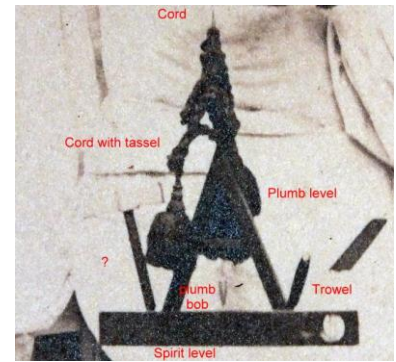

Searching for more information:

At the back of the framed photo was written by hand to whom this photo was sent:

Maurermeister August Nuhn, Arbeiterbildungsverein
That means:

Master mason, August Nuhn, Workers' Educational Association.

These associations were a special social group in



this county in southern Germany.

Now I had a name and could perform some research with my cell phone, which led me to the grandson of the master mason! 😊.

Unfortunately, the grandson could not recognize exactly his grandfather in the picture. For this the men in the center of the photo are looking too similar with their special beard. He has only photos from his grandpa. So we don't know, who exactly is August Nuhn on this photo. ☹

But I got some data of August Nuhn who was 34 years old in 1910 on the picture.

August Nuhn (*1876 - 1927+) had a business for construction work in Weingarten. After his dead in 1927 his eldest son Karl took over the business. For economic reasons, the business was abandoned in 1966.

The Workers' Educational Association in Weingarten was founded in June 1868 with 35 workers and closed in 1933.

For more information about the situation 1910 in Weingarten I am waiting for answers to my questions to the museum of the town. (Structure of the group of masons and plasterers, what kind of festival is the mentioned historical parade "Welfensage 1910", etc.)

Once I determine more about the type of festival held in 1910 and where the photo was taken, I will "fill in the details for everyone"!

When I cut off the photo from the frame there happened something funny: I found inside a colored cardboard to reinforce the photo with a reference to a food specialty in this region. (A butcher sharpens his knife and a pig begs for its life.)



Heute Metzelsuppe!

Today's Specials: PORK BOUILLON!
(Containing blood sausage, liver sausage etc.)

9. PRADA ADVERTISING WITH PLUMB BOB

From the wife of a friend I got this information. Did also men found this ad or is Prada too expensive for collectors? ☺
Thank you Anja.

In Prada's dalliance with conveniently handsome film festival darlings, its latest menswear as for Spring 2015 has been released starring **Ethan Hawke**, Ansel Elgort, and others. Photographed in crisp, seventies-inspired sets in London and New York by Craig McDean, **the actors are featured as holding familiar objects (like a plumb bob) in possibly the most unnatural ways possible.**

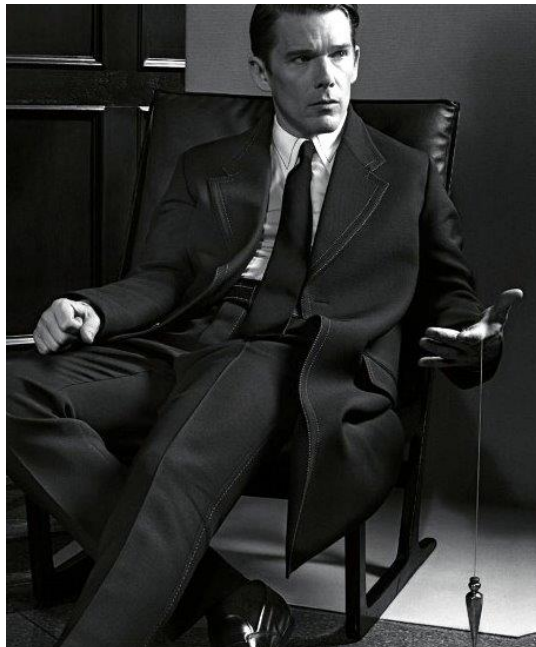
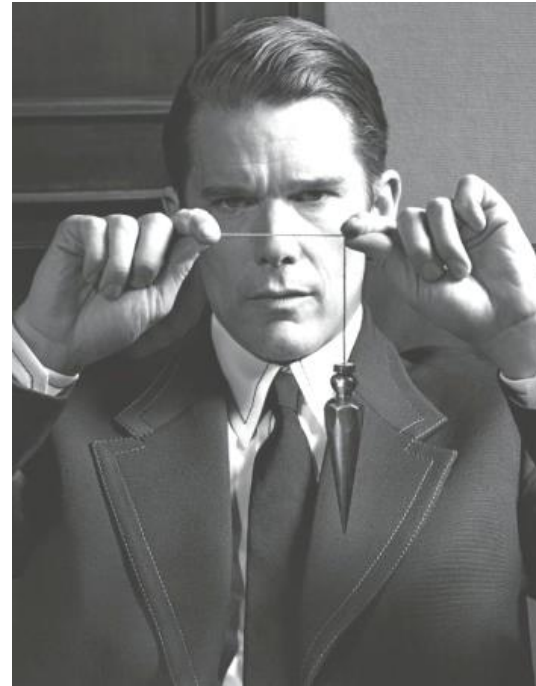

10. SOMETHING TO SMILE ABOUT

1922 CONTEST "MOST PERFECT BACK".

Measured with three plumb bobs.



Note: To get no problems for pornography, I have put a black spot on the photo.

The positive result for me: NO ONE WAS PERFECT!:

The contest revealed some surprising information. For instance, we are, every one of us, more or less lopsided. Not a single perfect backbone, even those of the winners, was discovered by any of the examining physicians. Very few of the contestants, according to Dr. Millard, have shoulders evenly aligned. Usually a difference of one-half to three-quarters of an inch in the level of the shoulders existed, and this tilt of the shoulders threw out the perfect alignment of the hips, so that in order to make an adjustment between the tilting shoulders and hips the backbone took on a slight scoliosis or twist which threw it out of plumb.

11. REMARK

DEAR READER OF THE PLUMB BOB NEWS,
DEAR FELLOW COLLECTOR,

This is an article of the regularly published WOLF'S PLUMB BOB NEWS that is sent on demand as PDF-file attachment by email. FREE. You can see all former publications on the website www.plumbbobcollectors.info on subpage "download publications". Remarks and contact by email: plumbbobwolf@t-online.de

Enjoy it

Wolf Ruecker

PS. This NEWSLETTER is also available in GERMAN /DEUTSCH.

plumbbobwolf@t-online.de

READERS of these pages will recall the recent article on the search made by doctors all over Canada and the United States to find a perfect backbone.

The idea was unique, but the physicians realized that no easy task confronted them to interest the average person in such a proposition. So an award of \$1,000 for the adult and \$500 for the child having the nearest to a 100 per cent spine was offered as an inducement to bring out as many spinal columns as possible for examination.

This contest, lasting some months, has just closed and the prizes have been awarded after more than 40,000 men and women and as many children stood under the plumb-bobs and spirit levels used by the doctors in making their measurements.

As a result Virginia Pearson, stage and screen star, has added \$1,000 to her bank account for having the most perfect back among the grown-ups, and Charles W. Boggs, Jr., of Oklahoma City, for having the best child's back, was given \$500 to start a fund to pay for his college education.

But before the winners obtained the money their backs were photographed and moulded in plaster and duplicates of the plaster casts are now being sent all over the world, particularly to doctors of osteopathy.

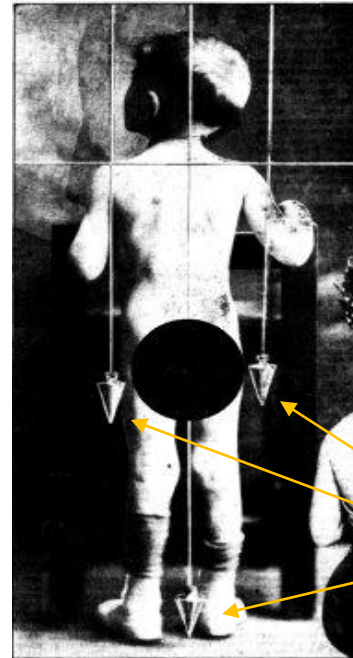

Little Charles Boggs, Jr., Who Won the First Prize as Having the Best Shaped Back Among the Children Entered in the Competition. The Parallel Lines Show the Two Almost Symmetrical Halves Into Which the Plumb-Bobs Divided Little Charlie's Back.



Logo of the IPBCA
INTERNATIONAL PLUMB BOB
COLLECTORS ASSOCIATION.
For us THE WORLD TURNS
AROUND THE PLUMB BOB